

LINSEIS

pushing boundaries

labotronic™

STA PT 1000
STA PT 1600
STA HP

Simultaneous **Thermal Analysis**





Since 1957 LINSEIS Corporation has been delivering outstanding service, know how and leading innovative products in the field of thermal analysis and thermo physical properties.

Customer satisfaction, innovation, flexibility, and high quality are what LINSEIS represents. Thanks to these fundamentals, our company enjoys an exceptional reputation among the leading scientific and industrial organizations. LINSEIS has been offering highly innovative benchmark products for many years.

Rooted in a strong family tradition, LINSEIS is proudly steered into its third generation, maintaining its core values and commitment to excellence, which have been passed down through the family leadership. This generational continuity strengthens our dedication to innovation and quality, embodying the essence of a true family-run business.

The LINSEIS business unit of thermal analysis is involved in the complete range of thermo analytical equipment for R&D as well as quality control. We support applications in sectors such as polymers, chemical industry, inorganic building materials and environmental analytics. In addition, thermo physical properties of solids, liquids, and melts can be analyzed.

LINSEIS provides technological leadership. We develop and manufacture thermo analytic and thermo physical testing equipment to the highest standards and precision. Due to our innovative drive and precision, we are a leading manufacturer of thermal Analysis equipment.

The development of thermo analytical testing machines requires significant research and a high degree of precision. LINSEIS Corp. invests in this research to the benefit of our customers.

C L A U S L I N S E I S
C E O D I P L . P H Y S .



The strive for the best due diligence and accountability is part of our DNA. Our history is affected by German engineering and strict quality control.

We want to deliver the latest and best technology for our customers. LINSEIS continues to innovate and enhance our existing thermal analyzers. Our goal is to constantly develop new technologies to enable continued discovery in Science.

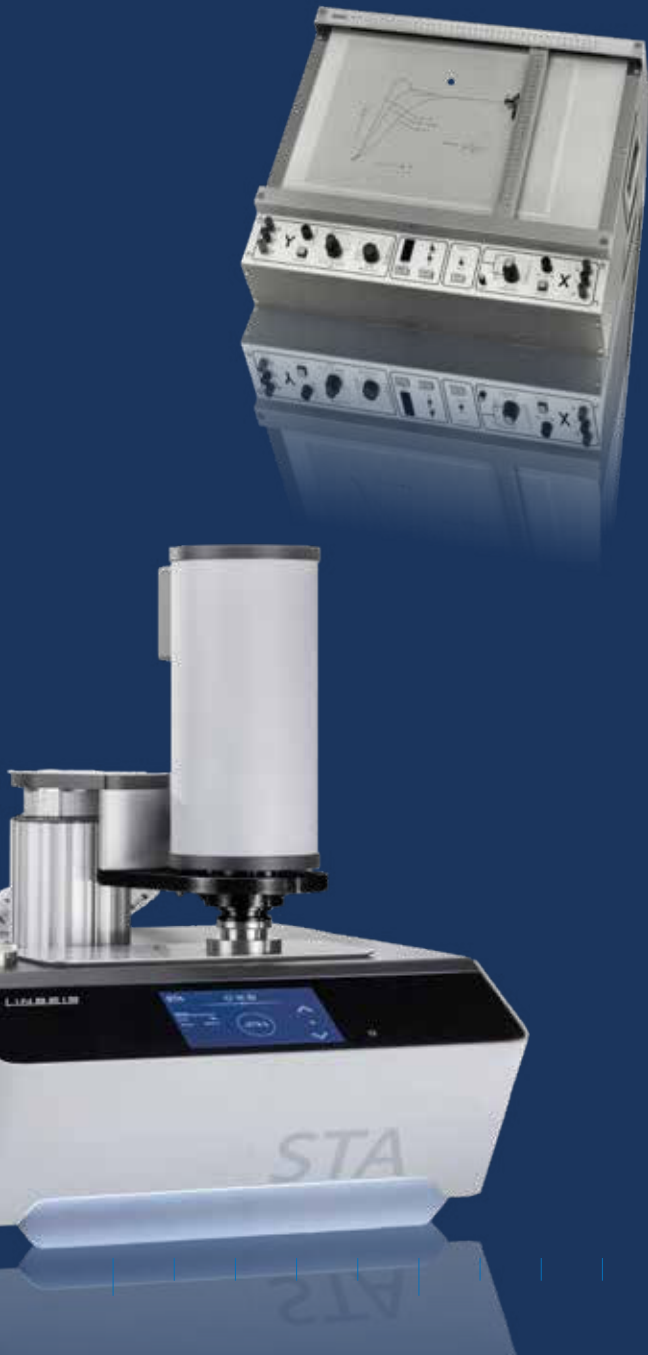

Engineering & Innovation

Simultaneous Thermal Analysis

Simultaneous TGA-DTA/DSC measures both, **heat flow** and **weight change** of a sample as a function of temperature or time under controlled atmosphere. Simultaneous measurement of these two material properties not only improves productivity but also simplifies interpretation of the results. The complimentary information obtained allows differentiation between endothermic and exothermic events which have no associated weight change (e.g., melting and crystallization) and those which involve a weight change (e.g., degradation).

STA

(Simultaneous Thermal Analysis)

DSC

(Differential Scanning Calorimeter)

TGA

(Thermogravimetry)



DSC-True Heat Flow measurement

Quantitative DSC-signal

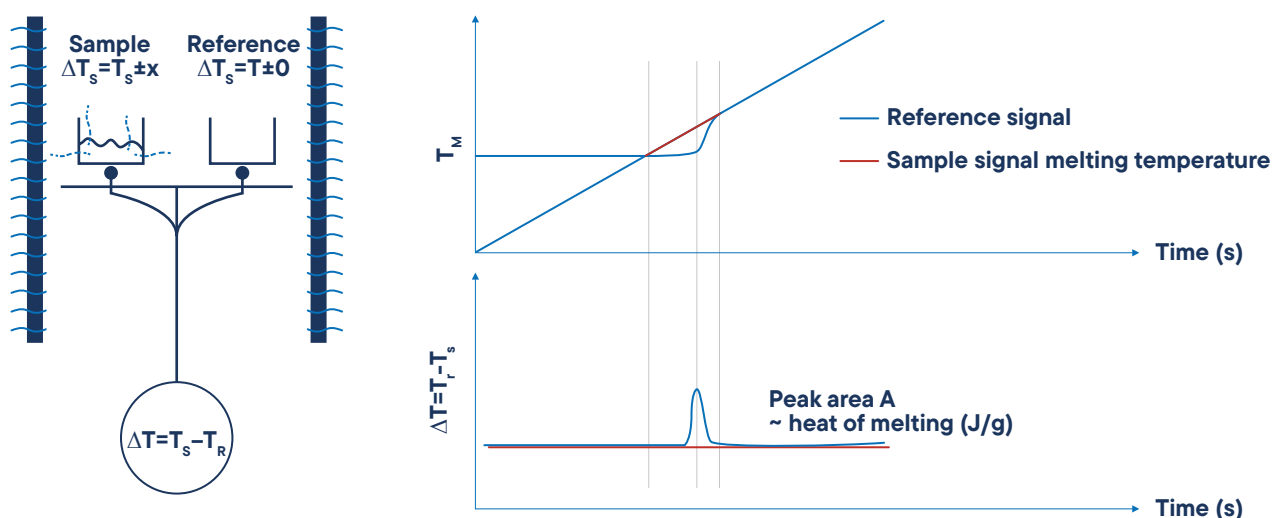

Differential Scanning Calorimetry (DSC)

A technique in which the difference in energy input into a substance and a reference material is measured as a function of temperature, while the substance and reference material are subjected to a controlled temperature program.

Differential Signal

The differential signal is displayed as a baseline. Effects, for example the melting of a metal, can be observed as a peak. The area of the peak gives the amount of enthalpy and the direction of the peak indicates the way of heat flux – endothermic (down) or exothermic (up).

Temperature vs. Time

During an effect like a reaction, decomposition or phase transition, a temperature difference (heat flux difference) between the sample and the reference crucible can be measured by means of a thermocouple.

Measurable Properties

- Mass change in % and mg
- Rate controlled mass loss
- Evaluation of mass loss
- Residue mass evaluation
- Compositional analysis
- Enthalpy
- Endo- / exothermic reaction
- Phase transition
- Melting point
- Glass point
- Crystallinity
- Thermal stability
- Oxidation stability
- Purity
- Solidus / Liquidus relationship
- Product identification

Sensors

Linseis STA can be equipped with an unmatched amount of different user exchangeable TG-DSC, TG-DTA or TG sensors. Each sensor is available with different thermocouples to provide the highest sensitivity for the desired temperature range and application.

- Al2O3
- Platinum
- Aluminium
- others

TG-DSC

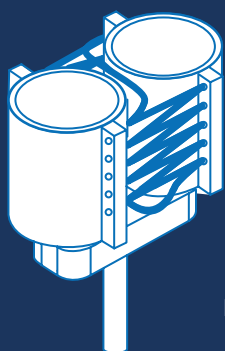

DSC Heat flux

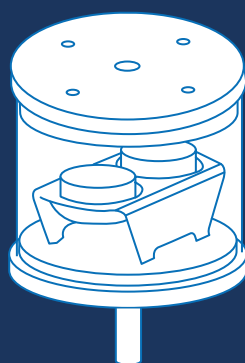

3D-Calvet-DSC sensor



0.12ml



0.12ml



custom volume



TG-DTA

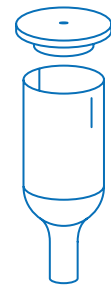
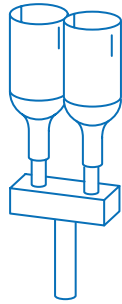
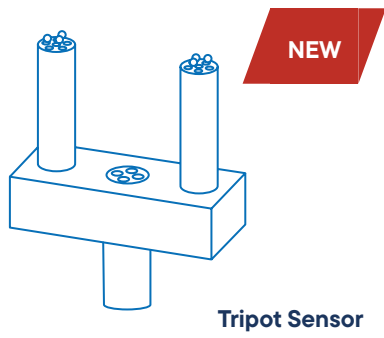

TGA

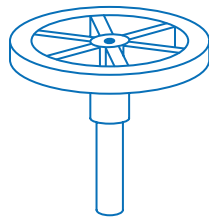
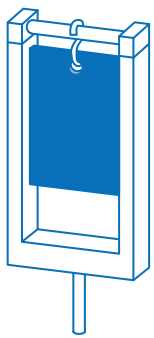

0.14 ml

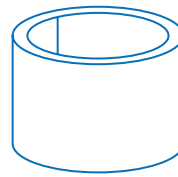

TG-sample holders for many different applications



custom volume



0.12 ml

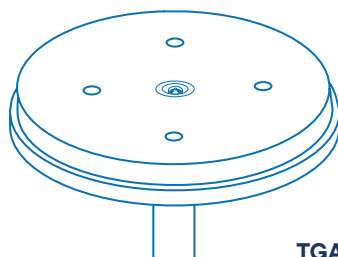
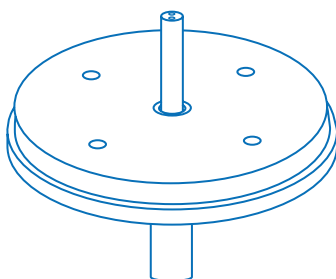
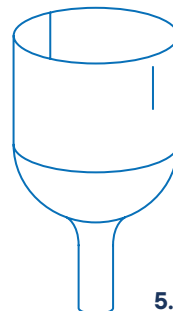
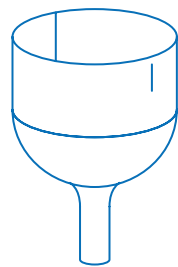
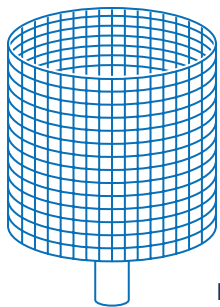
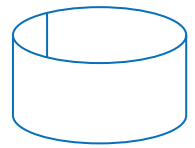

Best possible sensitivity for every application

Electromotive force / Temperature

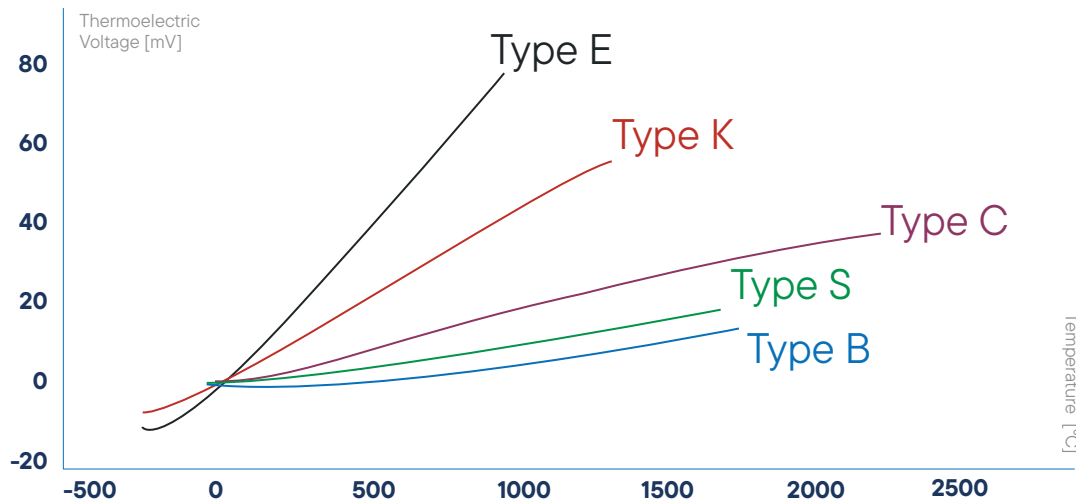

All sensors available with the thermocouples illustrated. LINSEIS sensor combinations cover the broadest temperature range in the market (-180°C up to 2400°C).

Furnace Programm

Temperature	Type	Element	Atmosphere	TC-Type
-70°C - 400°C	L81/264/RCF	HangDown only Intracooler / Kanthal	inert, oxid., red., vac.	K
-150°C - 500°C	L81/264/500	Kanthal	inert, oxid., red., vac.	K
-150°C - 700°C	L81/264/700	Kanthal	inert, oxid., red., vac.	K
-150°C - 1000°C	L81/264/1000	Kanthal	inert, oxid., red., vac.	K
RT - 1200°C	L81/HF	IR Heater	inert, oxid., red., vac.	S
RT - 1000°C	L81/220AC	SiC	inert, oxid., red., vac.	K
RT - 1600°C	L81/240AC	SiC	inert, oxid., red., vac.	S
RT - 1750°C	L81/250	MoSi ₂	inert, oxid., vac.	B
RT - 2000°C	L81/260/G/2000	Graphite	inert, red.	C
RT - 2400°C	L81/260/G/2400	Graphite	inert, red.	Pyrometer
RT - 2800°C	L81/260/G/2800	Graphite	inert, red.	Pyrometer
RT - 2400°C	L81/260/T	Tungsten	inert, red.	C
RT - 1000°C	L81/200	Glow igniter	inert, oxid., red., vac.	S/K

Benefits of the vertical top loading design

The vertical “sample on top” design of the LINSEIS thermo-balance provides highest possible accuracy due to a stable position of the sample and easy sample handling.

TGA/ STA PT 1000/1600

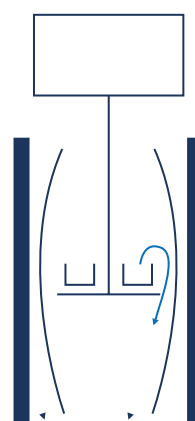
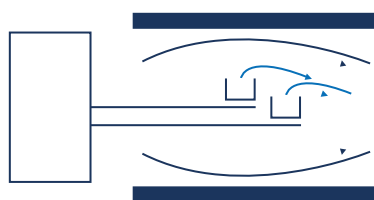
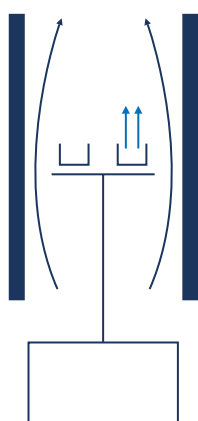

Vertical system (sample on top) LINSEIS configuration

Advantages:

- Easy sample handling
- Easy exchange of sample holder
- Stable position of the sample in the furnace

(critical for good DTA/DSC and Cp results)

Disadvantage:

- Complicated construction

Horizontal system

Advantages:

- Small buoyancy effects

Disadvantages:

- Very difficult sensor exchange
- Difficult sample handling
- Very high purge gas rate required
- Problems due to sensor expansion during heating/cooling

Vertical system (sample on bottom)

Advantage:

- Stable position within furnace

Disadvantages:

- Difficult sensor exchange
- “Dangerous” gas flow within balance housing (sample gets blown out)
- Sensor position depends on sample weight

New features

Software Improvements

- **Lex Bus Plug & Play:** Our latest software launch, Lex Bus, revolutionizes the way data communicates within our system, ensuring a more seamless and efficient integration of new hardware and software tools.
- **Improved Furnace Control:** The new and improved furnace control offers more precise temperature control, leading to significantly better measurement results.
- **New Software with User Interface:** Our communication is now even more focused on the needs of our customers, ensuring that you are always up-to-date and receive support whenever needed.
- **AI Support:** Intelligent hardware components and newly developed software assist users in conducting experiments and ensure maximum process safety.
- **Error Messages and Bug Fixes:** Our system now automatically detects errors and bugs, which are promptly fixed to minimize downtime.
- **Automatic Updates and New Features:** Our software receives regular automatic updates that not only improve security but also continuously introduce new features.
- **Permanent System Monitoring:** Our software constantly monitors system parameters to ensure optimal performance.
- **Preventive Maintenance and Problem Detection:** Our approach to preventive maintenance detects problems before they can cause damage, keeping your device in top condition.

Linseis Lab Link

Access over 75 years of experience with Linseis Lab Link, we offer an integrated solution to address uncertainties in measurement results. Direct access to our application experts via the software allows you to get advice on the correct measurement procedure. This direct communication ensures optimal results and maximizes the efficiency of your measurements for precise analysis and research.

Elektronik Upgrade

The new measurement electronics offer a significant performance improvement, inspired by the architecture of the „Linseis Digital Scale“. The benefits of this new digital balance architecture include:

- **Minimizing Drift:** Ensures consistently high precision over extended periods.
- **High Resolution:** Allows for more detailed data collection.
- **High Accuracy:** Improves the reliability of your measurement results.
- **Reproducibility:** Ensures consistent results with repeated measurements.

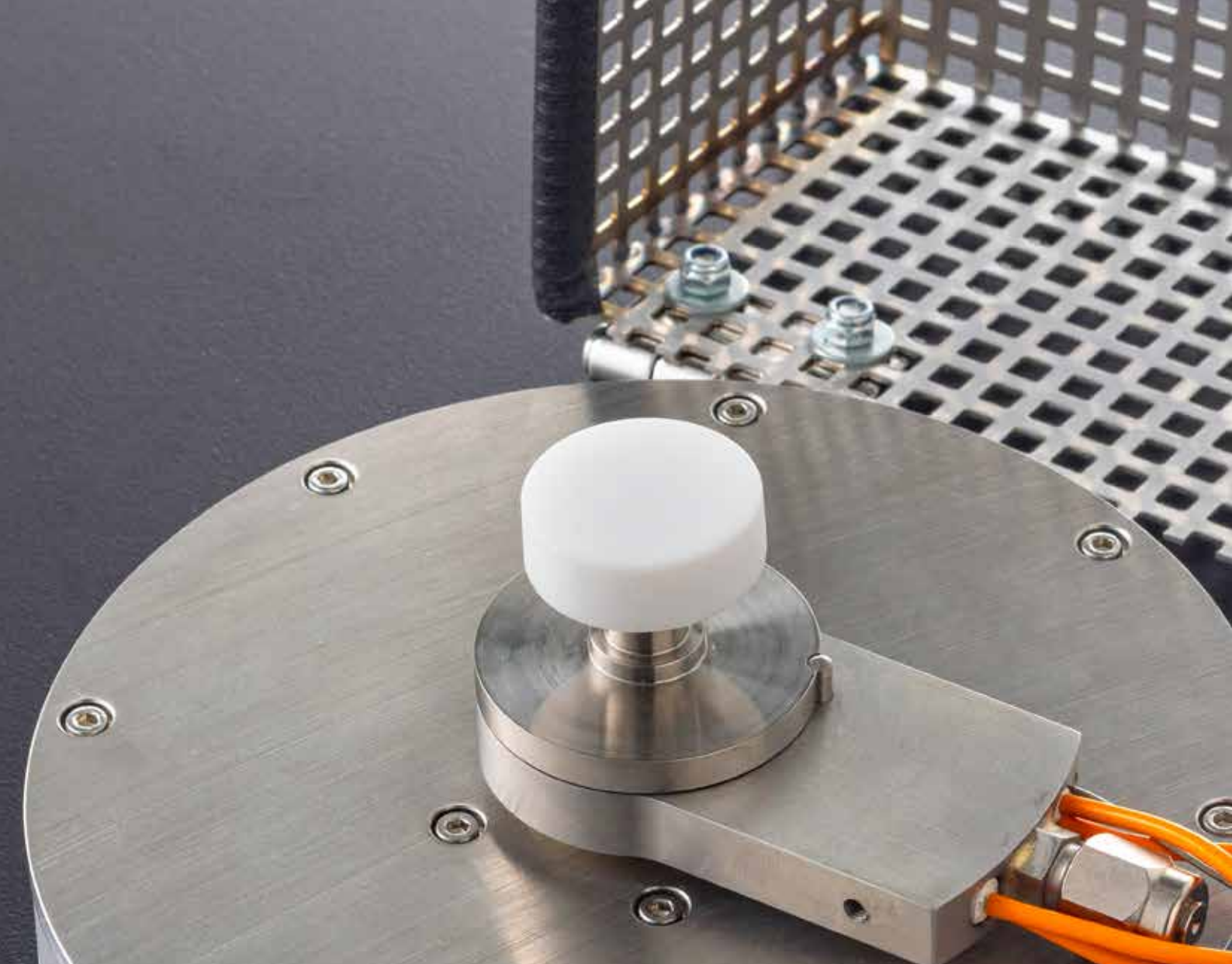

Design Improvements

The new device design is characterized by an elegant aluminum casing that is both robust and aesthetically pleasing. The LED status bar provides a user-friendly visualization of important information. A touch panel enables intuitive operation and contributes to a modern user experience that combines comfort and functionality. The new device design focuses on ergonomic operation.

New Hardware Features:

- **Tri-couple DTA Measurement System:** DTA measurement system with three thermocouples for the smallest endo-/exothermic effects in inhomogeneous samples.
- **Sheathed DTA Measurement System** for corrosive samples.
- **Patented „Forced Flow“ Procedure:** Allows forced flow through your TG or TG-DTA. Our system enables forced flow through the sample, introducing up to 100% reaction gas directly into the sample. This novel method allows for realistic measurements for the first time, scalable and enabling precise analysis under real conditions



Unique features

Automatic Evacuation

The devices feature a built-in automatic evacuation capability, ensuring efficient processes and smooth operation.

Vacuum and controlled atmosphere

- Supports high vacuum, inert, reducing, oxidizing, or humidified atmospheres
- Optional pressurization up to 5 bar overpressure
- Analysis of certain corrosive conditions with precautions
- Adaptability for residual gas analysis with optional heated capillary

Evolved gas analysis

Optional gas analysis with MS, FTIR, or GCMS is possible, providing valuable additional information. The system can be configured with standalone and integrated MFC for closing. Additionally, customer-specific options such as a heated inlet can also be integrated into the device.

Gas safety system

The gas safety system is designed to accommodate various gases such as hydrogen or carbon dioxide, ensuring secure operation and user safety.

Controlled humidity and water vapour

The devices regulate the humidity and water vapour during the measurement

Sample robot

Our STA PT 1000 and 1600 can be equipped with a proven sample robot for unattended sample measurements for highest true pot.

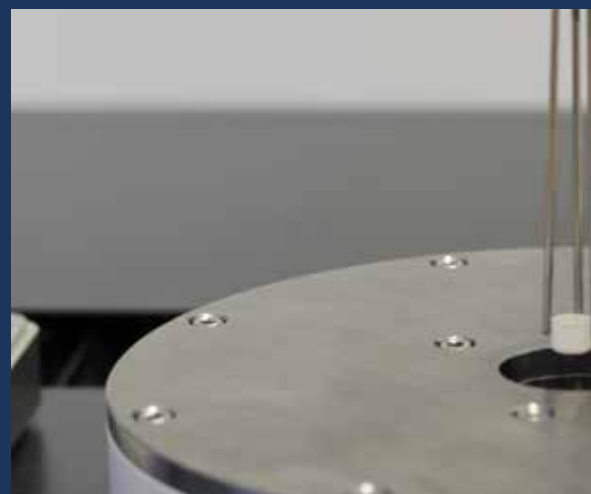

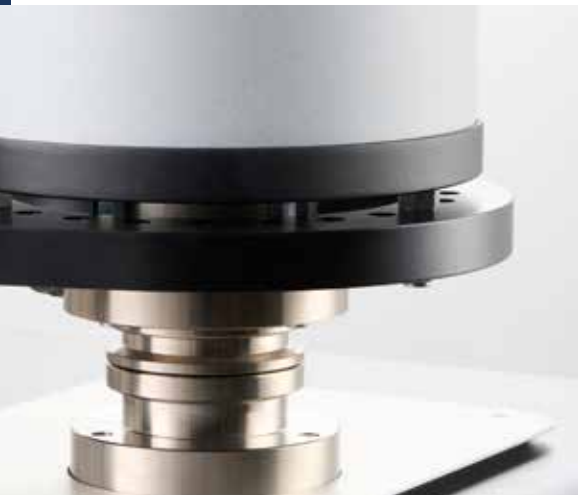

Wide temperature range -150°C to 2800°C

The LINSEIS STA instruments can be equipped with up to two furnaces at the same time. A broad variety of different furnaces is available to enable measurements in the widest temperature range on the market. Unmatched selection of furnaces for widest possible temperature range.

Automatic calibration

We offer an automatic calibration function in the software and hardware. With this function, our STA automatically calculates a calibration factor, which is also displayed.

Integrated LINSEIS platform

The integrated LINSEIS software offers a comprehensive solution, combining both hardware and software for maximum process security and precision. By providing a unified platform, it ensures seamless integration of components and devices from external partners, resulting in a highly robust system.



Customization

Close collaboration with the customers to tailor unique solutions, leveraging LINSEIS expertise to meet their specific needs.

Service

Our international presence across every continent enables us to deliver the best and fastest service possible.application.specific needs.

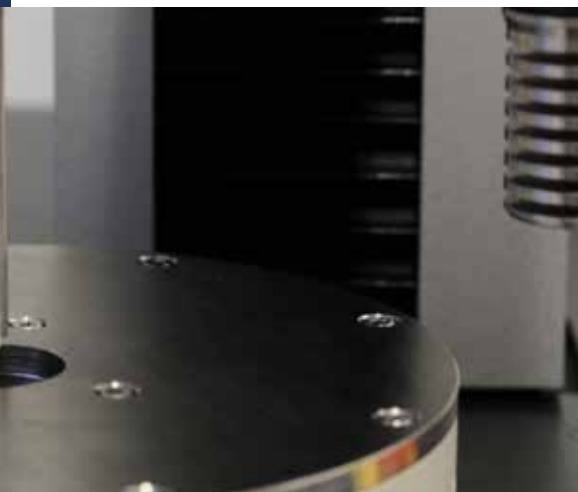

Accessories starter kit

The accessory starter kit guarantees fast and uncomplicated usage, serving as a complete system for instant application.specific needs.





Equipment for gas control and safety

Linseis instruments are all designed for being used in hydrogen atmosphere with just a few adjustments. The most important thing is a safety system that can ensure that there is no leakage and no explosive atmosphere generated outside of the instrument. Therefore, the Linseis safety system uses hydrogen sensors that are coupled to an automatic gas control panel. If there is a leakage or unwanted hydrogen release, the instrument is automatically flooded with inert gas and the hydrogen valves are closed. This ensures a minimum risk level during operation. Besides that, the system contains a burn off unit where the gas outlet is connected to, to ensure that also the used gas of the measurement chamber is not just released into the environment. The system can also be operated with several gas combinations of inert gases and even water vapor besides hydrogen.

In summary, the Linseis H2 control / safety system comes with the following benefits:

- Automatic evacuation function
- Gas flow control for multiple gases including water vapor and hydrogen
- Emergency shutdown function
- Hydrogen detector system
- Burn off unit



Fig. 1

Linseis equipment for operation under water vapor and controlled relative humidity

For many applications in thermal analysis, the atmosphere plays an important role as it may affect the sample behavior or activate reactions. Humidity influence on building materials, storage time of pharmaceuticals and foods or influence on mechanical properties of polymers are just some of the most common examples. Of course, the Linseis instruments are suitable for such experiments, however there is one fact that is often causing confusion and must be considered carefully: The difference between water vapor and relative humidity. Relative Humidity Generators (Fig. 1) are most commonly used for experiments around room temperature, while water vapor applications are most often at higher temperatures.



High precision beam balance

When water is heated to its boiling point or higher than that, the water changes its aggregate form from liquid to gaseous. It is then existing as water vapor (steam). If this steam is introduced into any kind of reaction chamber or instrument, it is called water vapor application. In contrast, every gas can transport and contain a certain amount of water at a given temperature. This is called humidity. Considering air as an example, there is always an amount of water contained in the air, even below the boiling point of water, which is defined as grade of humidity or relative humidity. In the following chapters, the difference shall be shown:

superior of classic

Our different microbalances are specifically designed to accomplish thermal analysis tasks in the best possible way. Providing ultra light weight design to follow fast weight changes and symmetric construction for ultra low drift long term measurements.

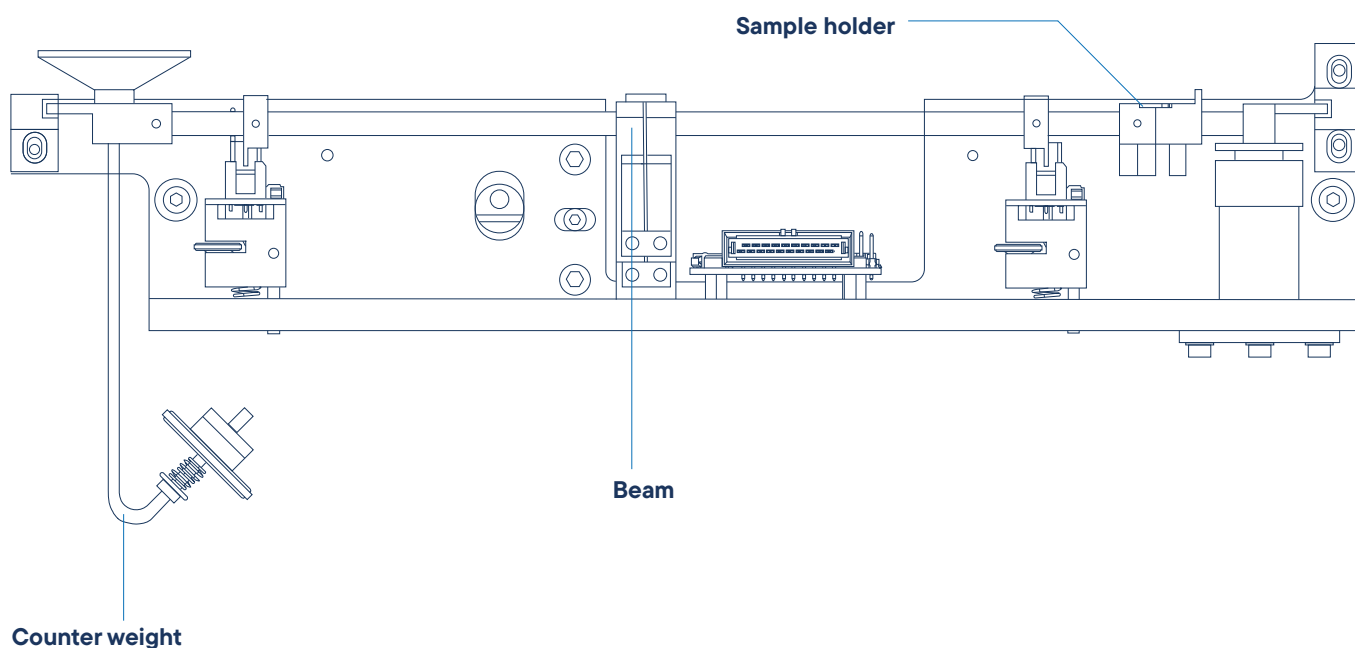

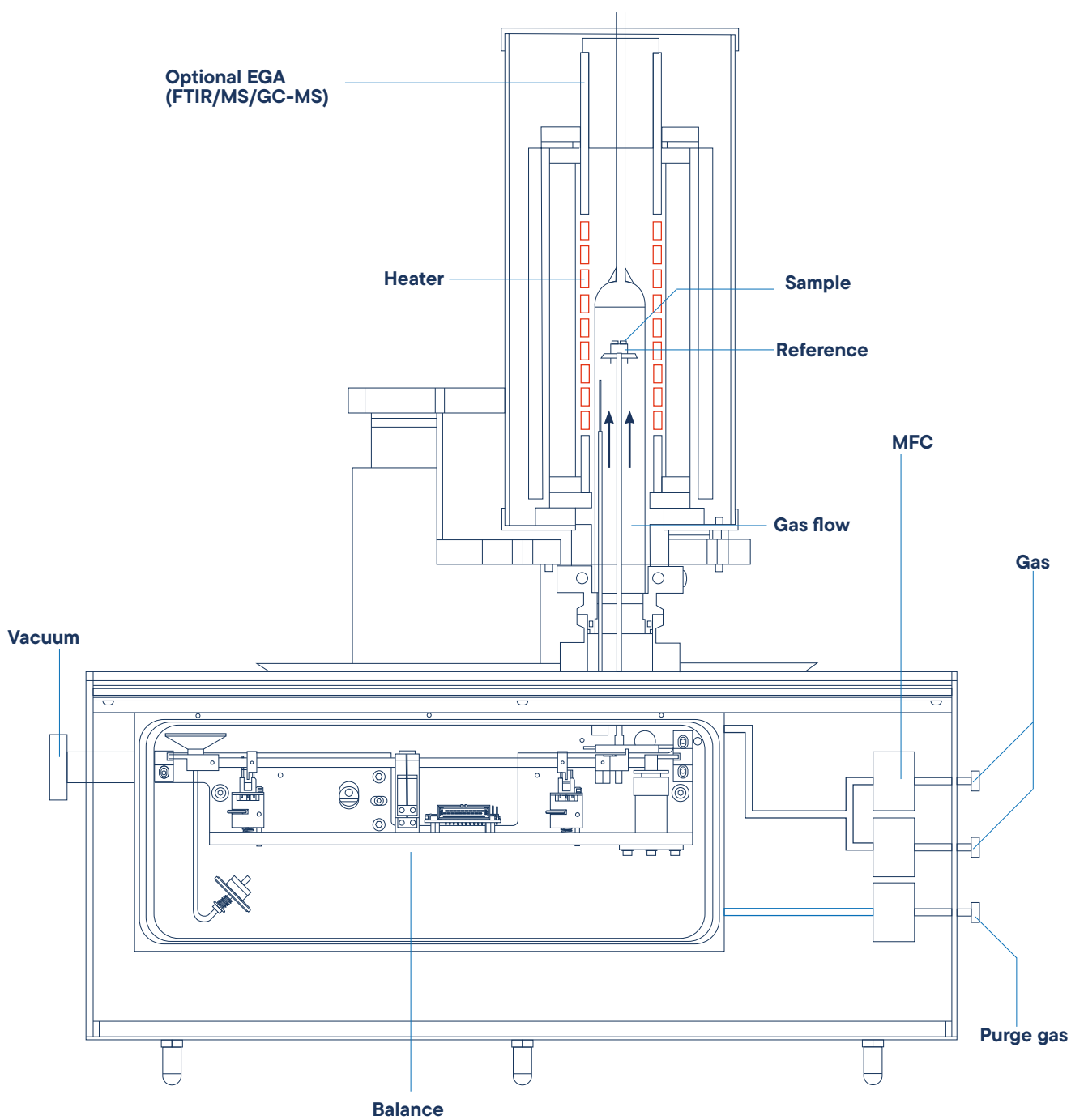

Advantages of LINSEIS balance design

- Sample mass compensation by a counter-weight enables improved sensitivity
- Improve symmetrical design for high interference levels
- Not affected by local gravity
- Not affected by thermal fluctuations

- Highest possible PRECISION
- Concept enables easy maintenance
- Depending on model, balance can handle from mg up to 50g sample mass

Advantages of combined TG+DSC

- Same geometry
- Stoichiometry
- Same temperature profile
- Same atmosphere
- Same humidity

deliv
outst

ser



ering

anding

vice

STA PT 1000

The STA PT1000 is dedicated to analysis of organic materials in a relatively low temperature range up to 1000°C. The LINSEIS HiRes option for TGA allows analyzing mass change effects with highest possible accuracy by effective trigger heating rate changes. The software can detect a mass change that could be due to oxidation or decomposition. As a result the unit can automatically adjust the heating rate or stop heating. After the mass change is over, the system continues heating according to the set profile. This allows a better separation of effects that are taking place shortly after each other or almost similar. The LINSEIS STA PT 1000 has an integrated furnace control cycle that enables the system to stop heating and perform heating rates with a minimum of overshooting so that a broad range of applications can

Design

Build in furnace and gas control furnace with low thermal mass for unmatched heating and cooling speed.

Sample robot

Optional 84 position sample robot is available.

New vacuum tight furnace for coupling



STA PT 1600

STA PT 1600/1

The highest resolution 0.025 µg balance for small sample quantities allows the detection of very small effects with highest accuracy.

STA PT 1600/2

The high mass variant allows measuring samples with big volumes or weight 35/50g to determine even small effects within a big amount of inhomogeneous material.

STA PT 1600/3

The standard model covers a broad application range with excellent resolution 0.1 µg and accuracy.

TG - DSC/DTA
+ Pressure





STA HP

High pressure & temperature

Taylor made STA product for challenging custom applications up to 150 bar.

Measurement System

The LINSEIS STA HP thermobalances are the only system available on the market to provide TG and DTA/DSC data under pressurized conditions from -150 up to 1800°C. The instrument offers a broad range of TG, TG-DTA and TG-DSC measuring systems which are easily exchangeable

Unique Features

Vacuum, Vapor and Controlled Atmosphere

The balance design provides for high vacuum (10-4mbar), inert, reducing or humidified atmosphere under static or flowing gas atmosphere. Corrosive conditions can be analyzed with proper precautions. A unique gas control for high pressure applications is available to ensure smooth gas flow switching under pressure conditions without affecting the TG signal. Furthermore, a sophisticated vapor generator can be supplied with the equipment.



STA HP 1/2



STA HP 3

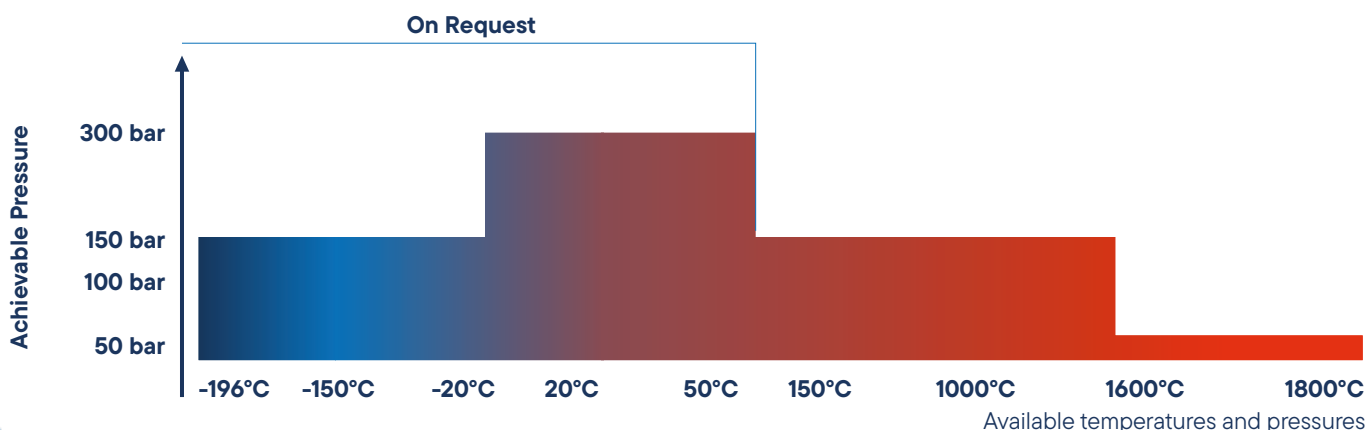

Software

All LINSEIS thermo analytical instruments are software controlled. The individual software modules run exclusively under Microsoft® Windows® operating systems. The complete software consists of 3 modules: temperature control, data acquisition and data evaluation. The Windows® software incorporates all essential features for measurement preparation, execution and evaluation of a thermoanalytical measurement. Thanks to our specialists and application experts, LINSEIS was able to develop comprehensive easy to understand user friendly application driven software.

Features-Software:

- Program capable of text editing
- Data security in case of power failure
- Thermocouple break protection
- Repetition measurements with minimum parameter input
- Evaluation of current measurement
- Curve comparison up to 50 curves
- Storage and export of evaluations
- Export and import of data ASCII
- Data export to MS Excel
- Multi-methods analysis (DSC TG, TMA, DIL, etc.)
- Zoom function
- 1 and 2 derivation
- Programmable gas control
- Curve arithmetics
- Statistical evaluation package
- Free scaling
- Automatic calibration
- Optional Kinetic and Lifetime Prediction
- Software packages

TG – Features:

- Mass change as % and mg
- Rate Controlled Mass Loss (RCML)
- Evaluation of mass loss
- Residue mass evaluation

HDSC – Features:

- Glass transition temperature
- Complex peak evaluation
- Multipoint calibration for sample temperature
- Multipoint calibration for change of enthalpy
- Cp calibration for heat flow
- Signal-steered measuring procedures

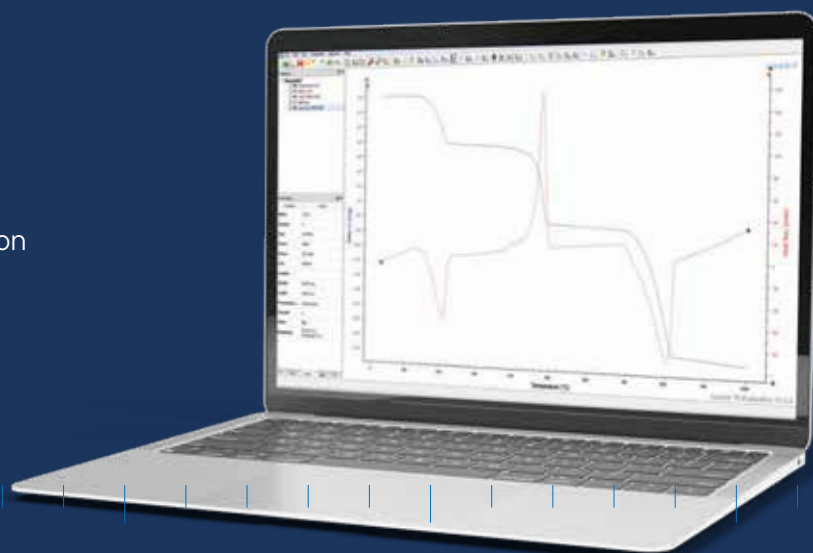

Measurement System

The LINSEIS Thermal Library software package comes as an option for the well-known, user friendly LINSEIS Platinum evaluation software that is integrated in almost all our instruments. The Thermal Library allows you the comparison of the complete curves with a data base providing thousands of references and standard materials within only 1-2 seconds.

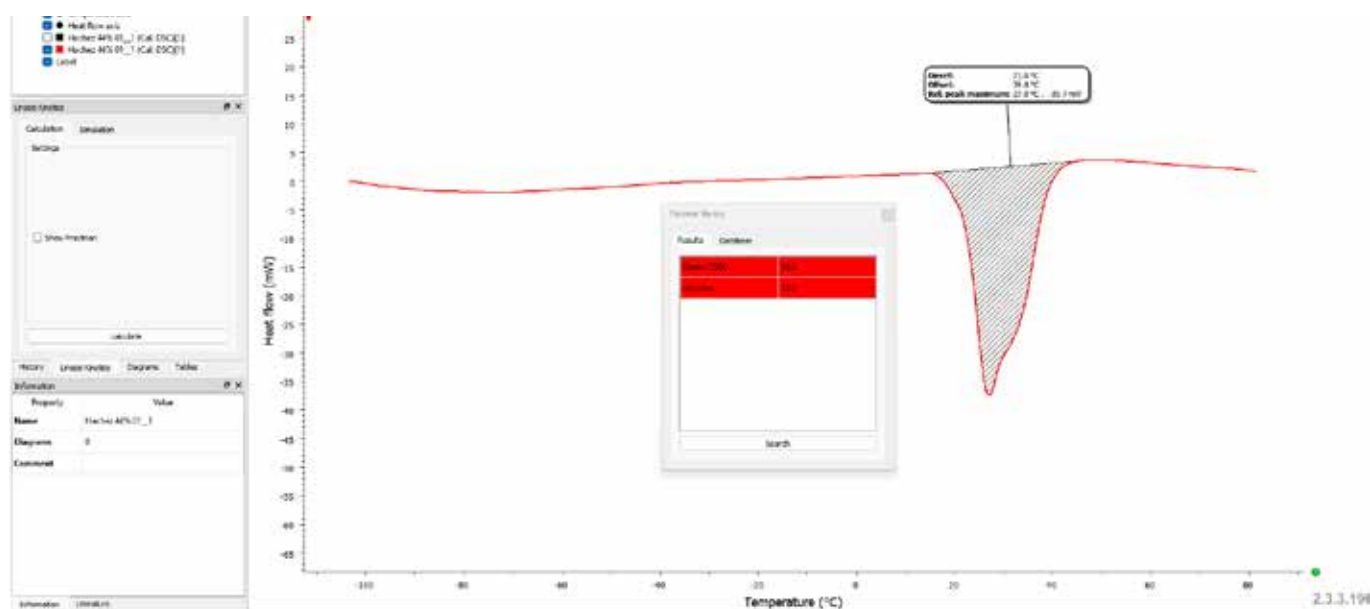

Multi-Instrument

All LINSEIS instruments DSC, DIL, STA, HFM, LFA, etc. can be controlled from one software template.

Report Generator

Convenient template selection to generate customized measurement reports.

Kinetic software

Kinetic analysis of DSC, DTA, TGA, EGA (TG-MS, TG-FTIR) data for the study of the thermal behavior of raw materials and products.

Multi-Lingual

Our software is available in many different user exchangeable languages, such as: English, Spanish, French, German, Chinese, Korean, Japanese, etc.

Multi-User

The administrator can generate different user levels providing different rights to operate the instrument. An optional Log file is also available.

Data Base

State of the art data base design enables easy data handling, with up to 1000 data sets.

Technical Specifications

	STA PT 1000	STA PT 1600			STA HP	
Temperature range	RT up to 1000°C	-150°C up to 500 / 700 / 1000°C RT up to 1000 / 1400 / 1600 / 1750 / 2000 / 2400°C			170°C up to 1200 / 1600 / 1800°C	
Vacuum	optional 10 ⁻² mbar	10-5 mbar (depends on vacuum pump)			up to 10-4mbar	
Pressure		up to 5 bar (optional)			up to 150 bar custom solution on request	
Heating rate	0.01 up to 100K/min	0.01 up to 100K/min (depends on furnace) (from 0.001°C/min on request)			0.01 up to 300K/min (STA HP3) 0.01 up to 100K/min (STA HP1)	
Temperature precision	0.001°C	0.001°C			0.05°C	
Sample robot	optional 42 / 84	optional 42				
TG		1	2	3		
Resolution	0.01 µg	0.02µg	0.1 µg	0.01 µg	0.01 µg	0.01 µg
Sample weight	Balance can read weight automatically	Balance can read weight automatically			Balance can read weight automatically	
Measuring range	25 / 2500 mg	25 / 2500 mg	25 / 2500 mg	35000 mg	25 / 2500 mg	35000 mg
DSC						
DSC-sensors	E / K / S	E / K / S / B / C (C = DTA only)			E / K / S / B / C	
DSC resolution	0.3 / 0.4 / 1µW	0.3 / 0.4 / 1 / 1.2 µW			0.3 / 0.4 / 1 / 1.2 µW	
Calorimetric sensitivity	approx. 4 / 6 / 17.6 µW	approx. 4 / 6 / 17.6 / 22.5 µW			approx. 4 / 6 / 17.6 / 22.5 µW	
DTA						
DTA-resolution	0.03 nV	0.03 nV			0.03 nV	
Sensitivity	1.5 µV/mW	1.5 µV/mW			1.5 µV/mW	
DTA-measuring ranges	250 / 2500 µV	250 / 2500 µV			250 / 2500 µV	



*push
bound*



Whining !aries

Applications STA PT 1000

Decomposition of rubber

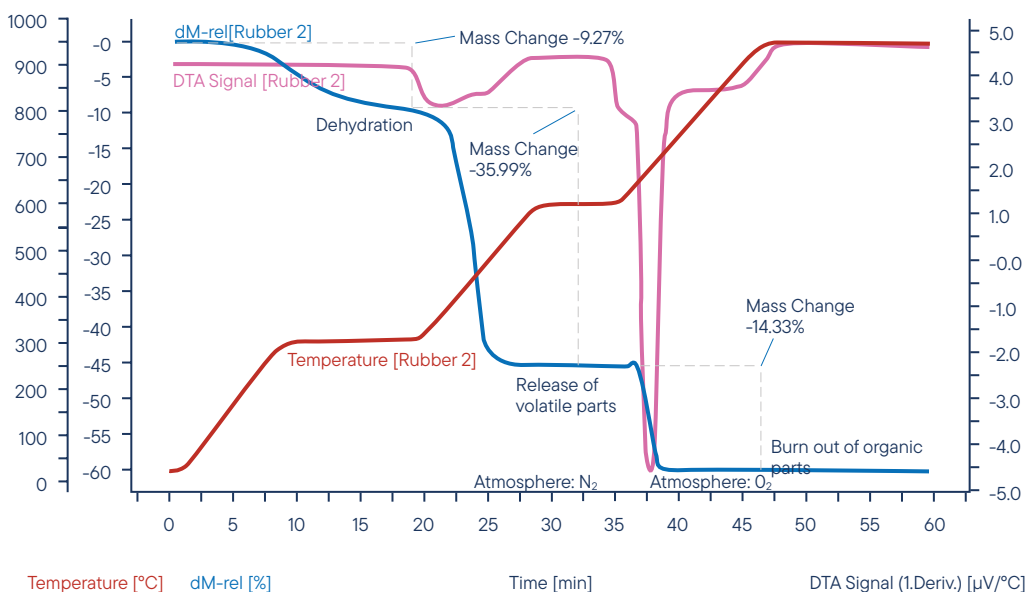

In the first step of weight loss, the dehydration of the sample takes place. The amount of water was 9.27%. In the second reaction step, the volatile components are released by pyrolysis under N₂ atmosphere. The amount of these components is 35.99%. For the third reaction step, the atmosphere is changed to O₂ – all organic components are burned out. The loss in weight is 14.33%. The remaining 40.41% are inorganic components like ashes, slake or fillers.

Aspirin

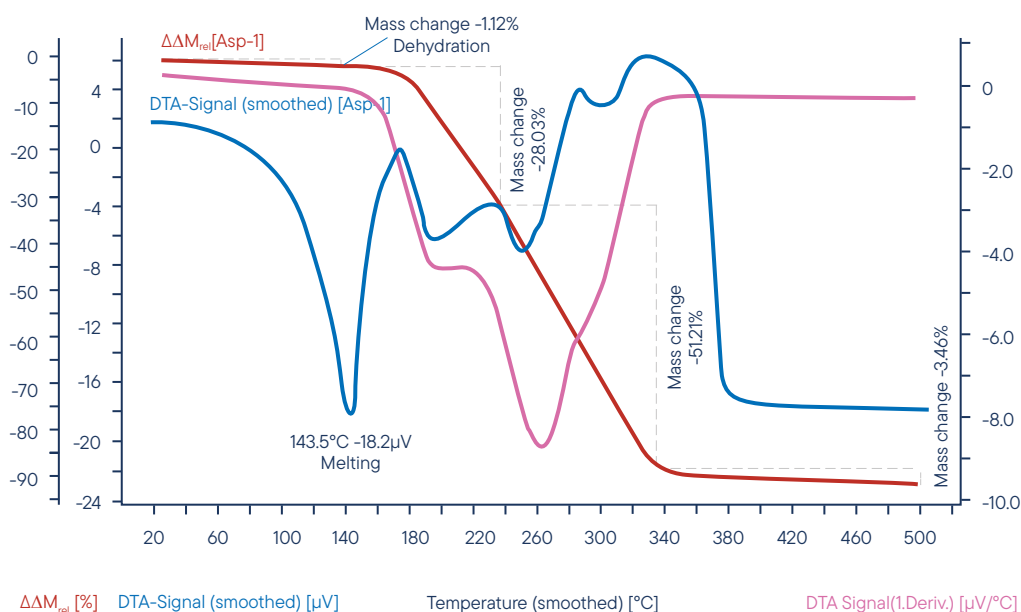

At the beginning of the heating process some adsorbed water is released, resulting in a weight loss of around 1%. At 140°C the melting point of the Aspirin is reached, resulting in an endothermic reaction, measured on the DTA trace. At 60°C the decomposition of the melted drug takes place in several stages. The decomposition products are volatile thereby giving a total weight loss of almost 100%.

STA HP

Hydrogen Adsorption on Titanium at 700°C

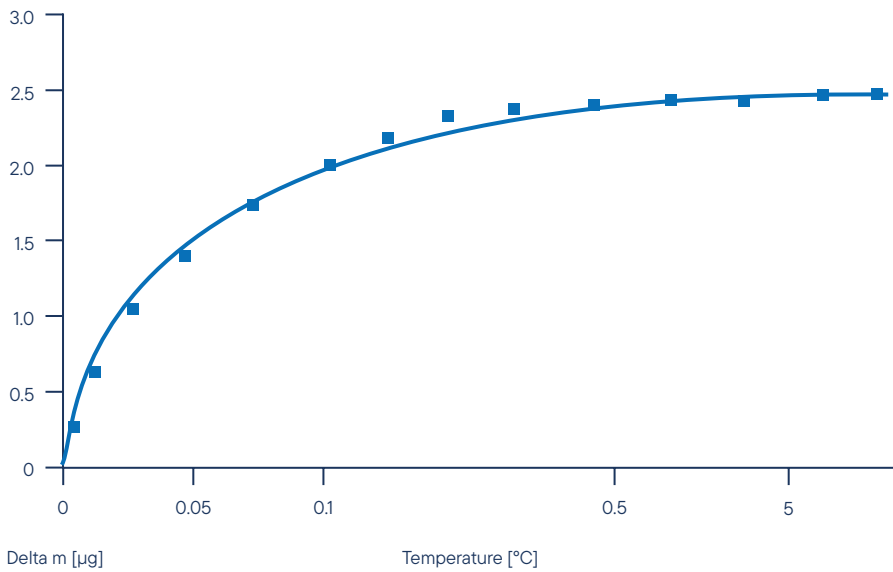

Activated, porous titanium surface was heated to 700°C under vacuum. At target temperature, hydrogen was added and the pressure was increased in an isothermal stage. The weight increase of the sample gives the amount of hydrogen that is adsorbed on the titanium surface over pressure, leading to saturation (2.5% weight) at 5 bar.

Coal gasification

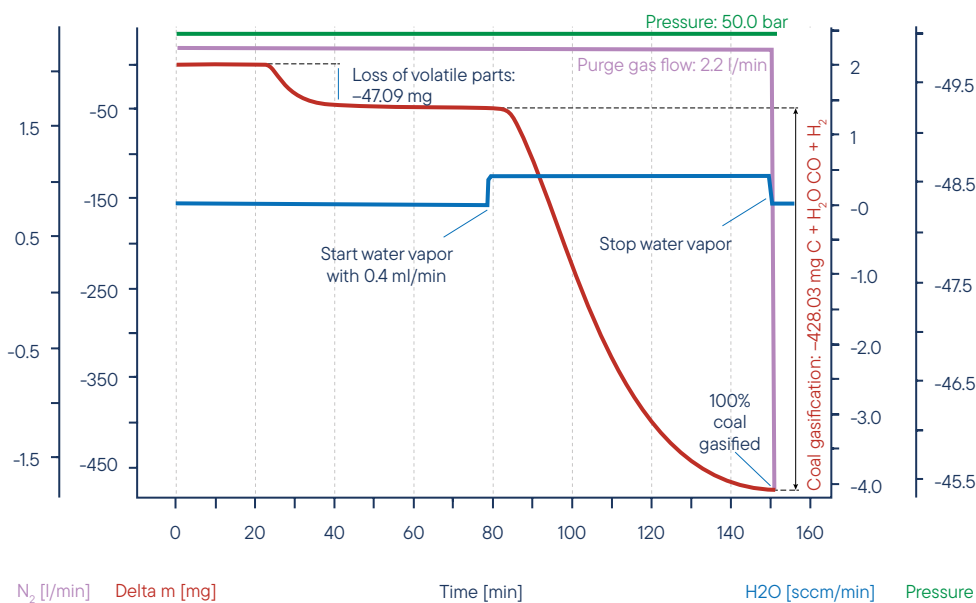

Coal was heated under nitrogen atmosphere at 50bar pressure. The mass signal shows the loss of volatile components between 20 and 40min. After water vapor was added, the coal was gasified and nearly completely consumed after 150min, leading to H₂, CO, CH₃OH and other useful reactive gases.



Linseis Service Lab

Hydrogen Adsorption on Titanium at 700°C

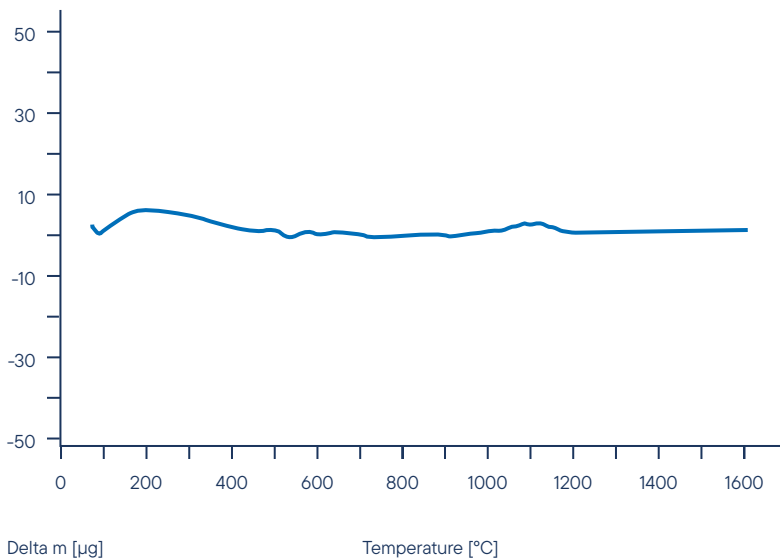

The average baseline stability during linear heating up to 1600°C is within a range of 5µg. This allows highest accuracy and repeatability during the most demanding applications on STA.

Coal gasification

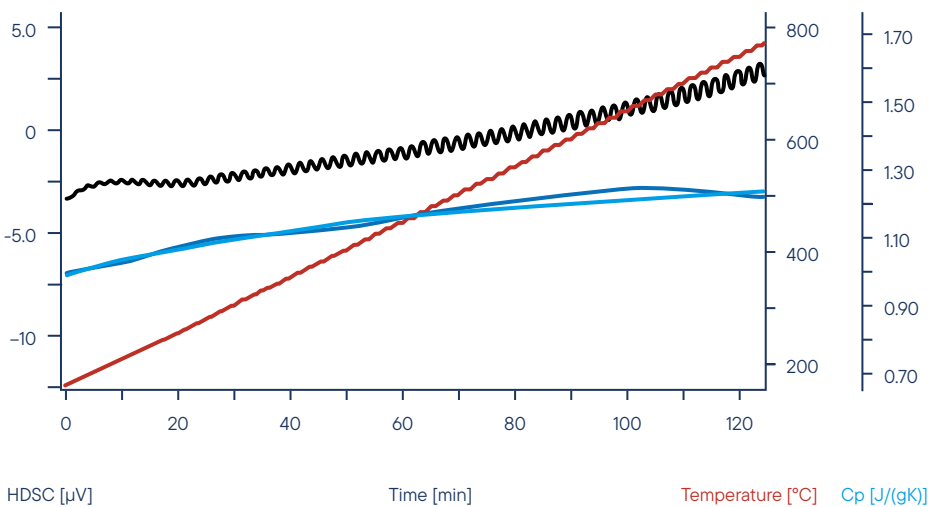

For highest possible accuracy of Cp, the LINSEIS STA and DSC allow the usage of modulated temperature profiles. This technique causes a continuous change in heat flow of the sample and the system can monitor the heat uptake much better than with a linear heating profile. The deviation from the literature value is much smaller than with non-modulated DSC profiles. The modulated heat flow signal (black) leads to a significant better Cp data (dark blue) that is only slightly different from literature (bright blue). The orange curve shows the modulated temperature signal.

LINSEIS

pushing boundaries



LINSEIS GmbH Germany

Vielitzerstr. 43
95100 Selb

Tel.: (+49) 9287 880 0
E-mail: info@linseis.de

LINSEIS Inc. USA

109 North Gold Drive
Robbinsville, NJ 08691

Tel.: (+1) 609 223 2070
E-mail: info@linseis.com

LINSEIS China

Kaige Scientific Park
2653 Hunan Road
201315 Shanghai

Tel.: (+86) 61 90 12 03
Tel.: (+86) 50 55 06 42
E-mail: info@linseis.com.cn

LINSEIS India

Plot 65, 2nd Floor, Sai Enclave,
Sector 23, Dwarka05-800
110077 New Delhi

Tel.: +91-11-42883851
E-mail: sales@linseis.in



WWW.LINSEIS.COM

03/2024